

Vehicle Fire Protection

An Owner's Manual for ANSUL
Fire Suppression/Detection Systems

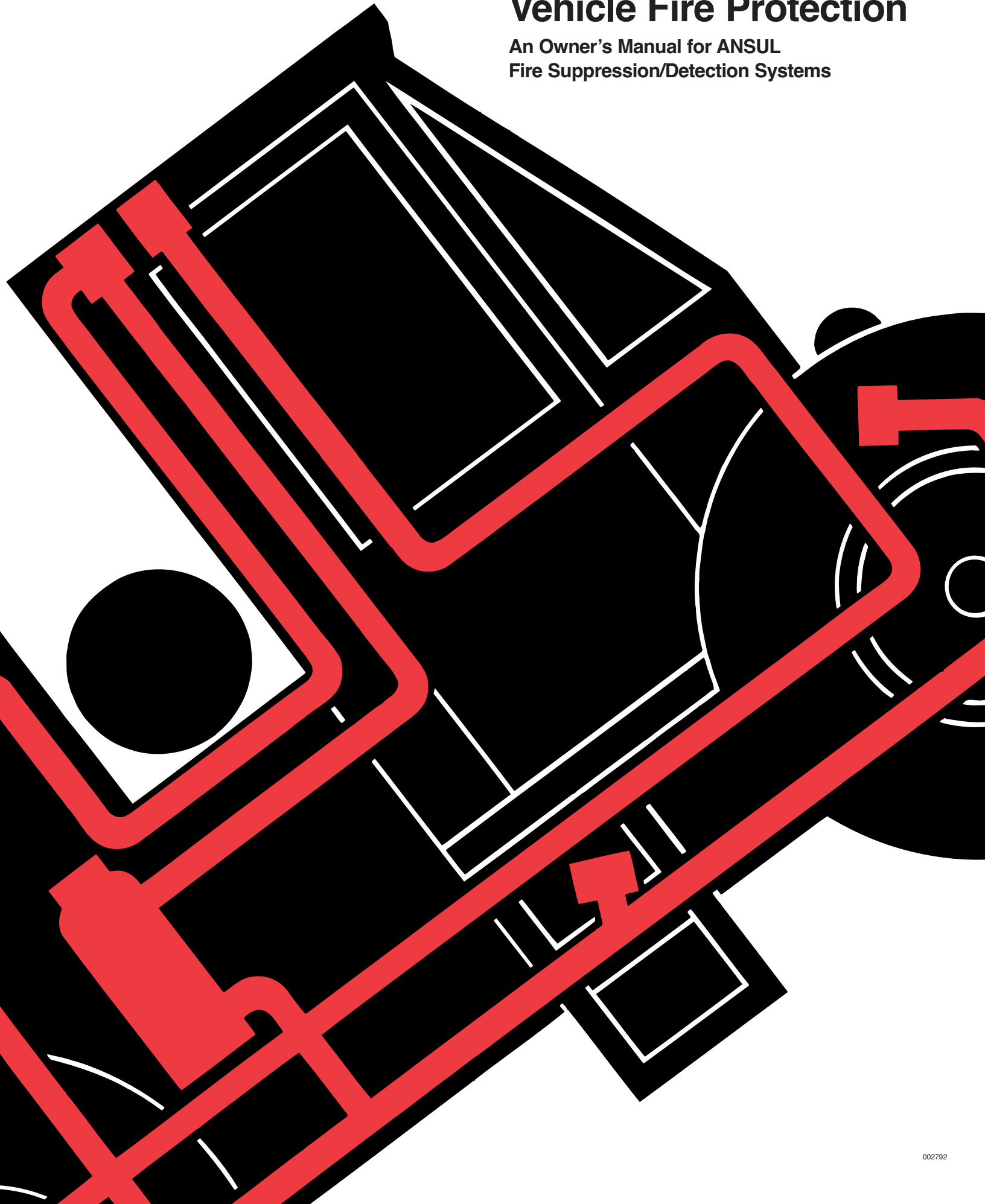

Off-road vehicles do have fires

Statistics show that off-road vehicles burn...with alarming frequency. These vehicles are susceptible to fire for several reasons. They often operate steady for several hours at a time (sometimes around the clock). They use flammable liquids – lubricating oil, gasoline, diesel oil, greases and hydraulic fluids – in their normal operation. They also generate heat – from engine blocks, manifolds, turbochargers and brake systems – which can ignite these flammable liquids and debris.

Since the passage of the federal and state clean air acts, many vehicles, including most busses operated by mass transit authorities and state agencies, have been converting to cleaner burning fuels such as LPG, LNG, and CNG instead of gasoline or diesel fuel. Use of these fuels is an essential component of improving our environment, but their use raises the possibility of dangerous gas leaks.

When fire breaks out, it can result in expensive repair or replacement of valuable equipment, costly downtime or loss of business continuity. Worse yet, it can mean serious personal injury to vehicle operators or passengers.

Insurance companies are well aware of these facts. That's why insurance rates are skyrocketing.

As the owner of a vehicle equipped with an ANSUL Fire Detection/Suppression System, you've taken an important step in facing the fire problem. You are dramatically reducing your potential fire loss and helping to ensure personnel safety.

This owner's guide has been provided to help you understand how your ANSUL Fire Detection/Suppression System works, your responsibilities for fire prevention and maintenance, and what to do in case of fire. In no way is this guide intended to provide detailed installation instructions. Should you have any questions or require assistance, contact your nearest authorized ANSUL products distributor or ANSUL Technical Services.

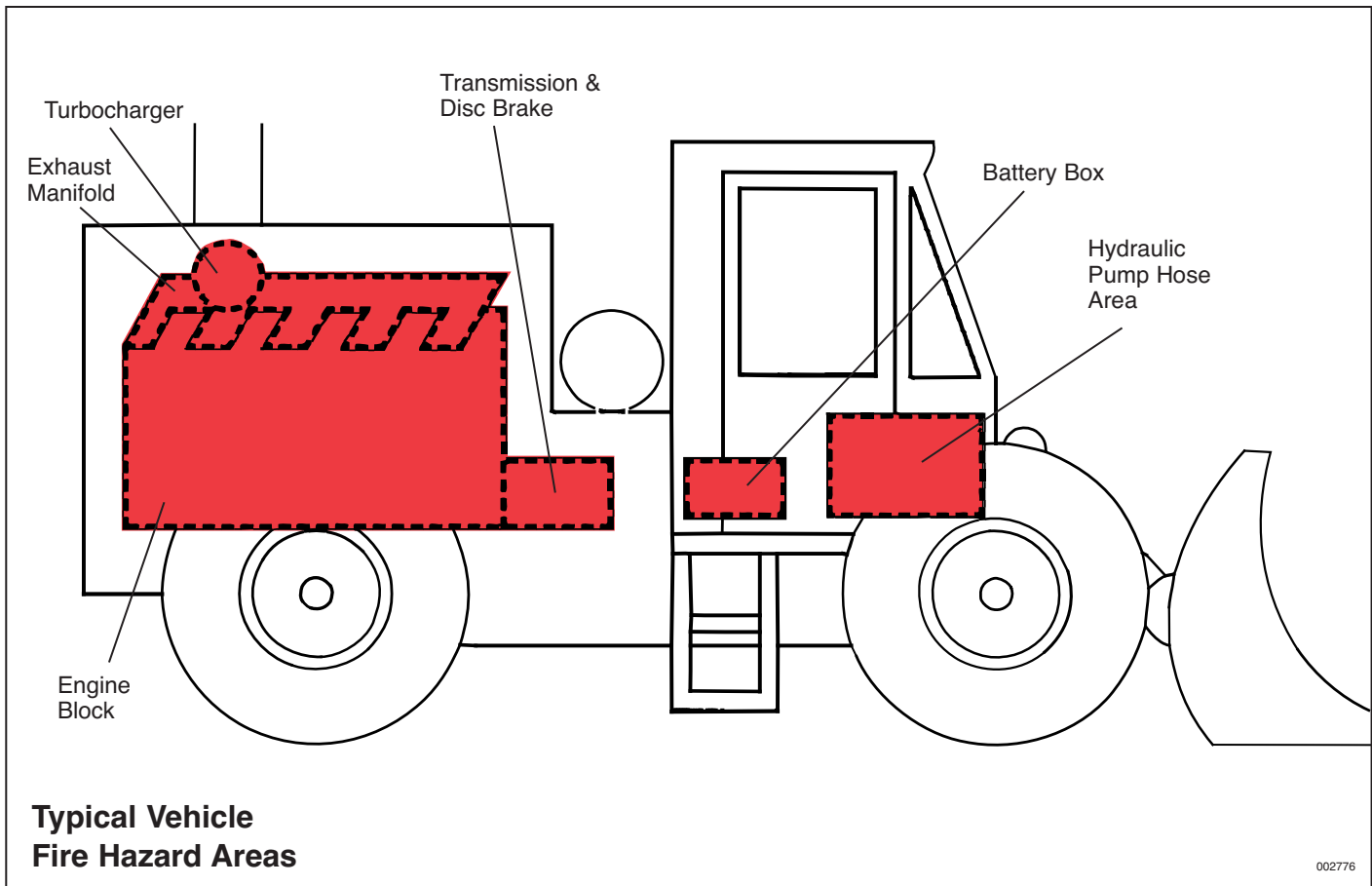

SAFETY PRECAUTIONS

The fire system described in these materials is a suppression system only and is not designed or intended to extinguish all fires, particularly when unusual amounts of combustible materials and an ample oxygen supply are present. It is extremely important that alternative firefighting equipment be available in case the system does not totally extinguish a fire.

Use extreme care to prevent the accumulation of debris, combustible materials and fluids which could intensify the fire or cause it to spread to areas where there was no previous potential for fire.

If modifications are made to the equipment being protected or if the fire detection and/or suppression system is disconnected for any reason, make certain the fire equipment is immediately inspected and tested by an authorized ANSUL vehicle systems distributor.

If an automatic fire detection and actuation system has not been supplied or has been disconnected, system actuation and discharge will not occur unless the fire suppression system is manually actuated. Reliance on a manual release system usually results in a slower reaction to fire.

Your role in protecting your vehicle from fire

Your ANSUL Fire Suppression System is custom-designed to protect specific hazard areas on your vehicle. It's been carefully engineered for reliability and built to the highest quality standards. Every component has been tested to ensure long life and dependable performance.

With proper maintenance, your ANSUL Fire Suppression System should give you years of fire protection.

The main purpose of the manual, however, is to explain the most basic form of fire protection – fire prevention. It outlines steps you can take to prevent a disastrous fire. Precautions which can greatly reduce the risk of serious fire damage.

Fire prevention on vehicles relies upon two basic factors:

- 1.** Inspection and preventative maintenance at points where fires are most likely to start – engine blocks, electrical systems, turbochargers, exhaust manifolds and brake systems.
- 2.** Regular cleaning of all areas where flammable materials such as fuel, oil, grease, hydraulic fluid and combustible debris may collect.

Vehicle Fire Prevention Maintenance

The following is a suggested daily maintenance outline which can help reduce the risk of fire on your vehicle.

CAUTION: Take care during vehicle maintenance, cleaning, or welding. To avoid unintentionally setting off the system and the discharge of agent, do not cut, pinch, or apply heat exceeding 200 °F (93 °C) to the detection lines of the system.

1. Check all oil, hydraulic fluid and gas lines for cuts, abrasions or undue wear. Replace as needed.

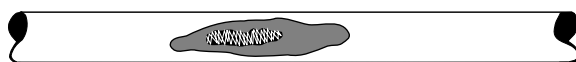

000620

2. Inspect all oil, hydraulic and gas line fittings for tightness. Clean off all residue and tighten.

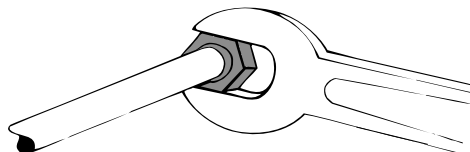

000621

3. Inspect and clean engine area. Depending upon the operation of the vehicle, use water or steam to clean it. Schedule cleaning for the end of the work shift when heat buildup may occur after the engine is shut down.

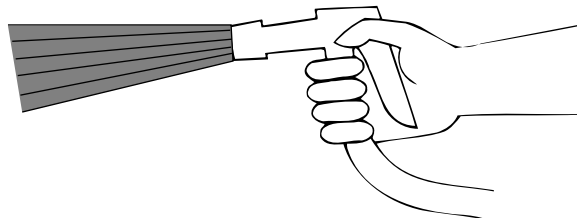

000622

4. Check braking system for proper adjustment – especially if brakes overheat when not engaged.

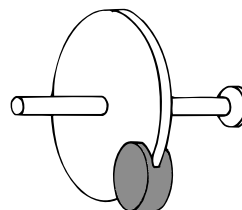

000623

5. Check all possible ignition points (engine block, exhaust manifolds, turbochargers, etc.). Make sure oil, hydraulic fluid and gas lines are not in contact with these ignition points.

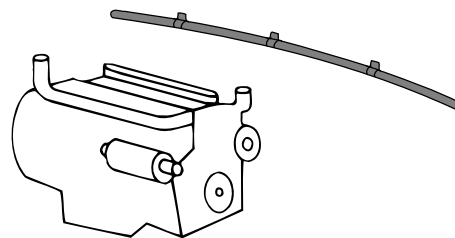

000624

6. Clean vehicle of all combustible debris – dry vegetation, grain particles, coal dust, etc. Also, remove any oil and fuel drippings.

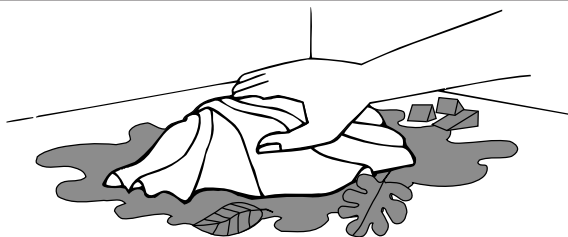

000625

7. Check all electrical lines and connections for tight fit, wear or abrasion. Replace any defective electrical equipment or wiring.

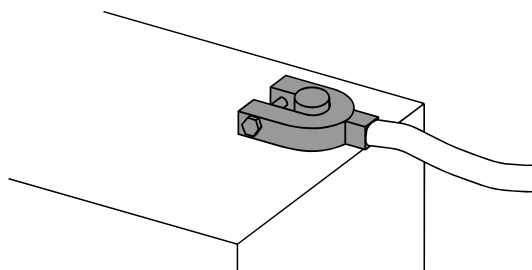

000626

How your ANSUL Fire Suppression System works . . . manually

1. A fire starts in the protected area. Equipment operator should bring equipment to a complete stop, set the brake, and turn off the engine.

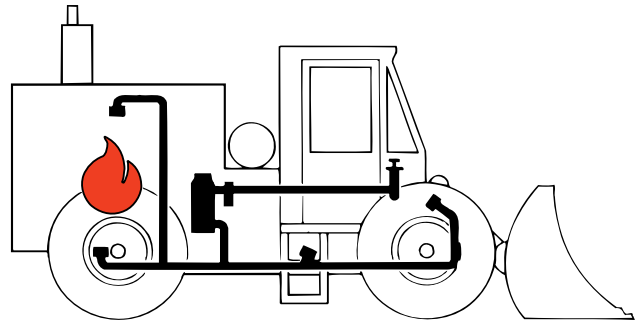

002777

2. Equipment operator pulls the ring pin and strikes the plunger on the manual actuators. Pressure from the actuator causes the ANSUL Fire Suppression System to actuate.

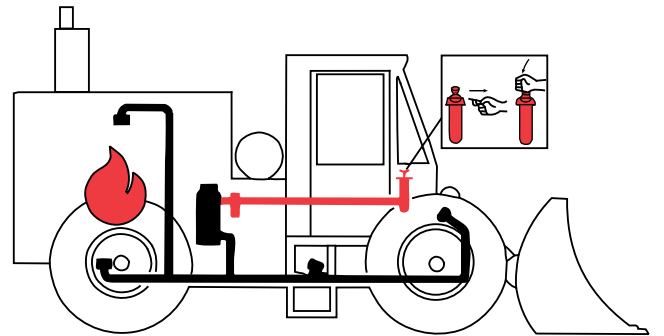

002778

3. Expellant gas pressure "fluidizes" the dry chemical extinguishing agent and propels it through distribution hose.

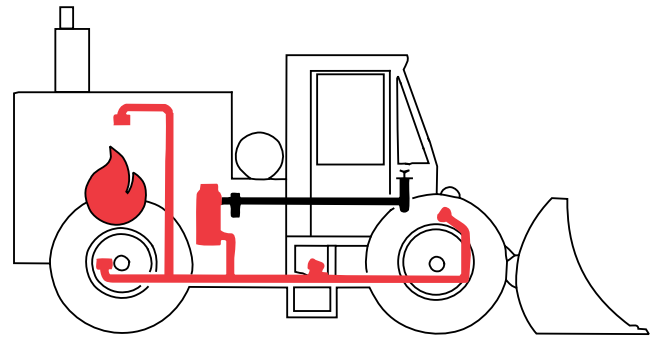

002779

4. Dry chemical extinguishing agent is discharged through fixed nozzles into protected areas, suppressing the fire.

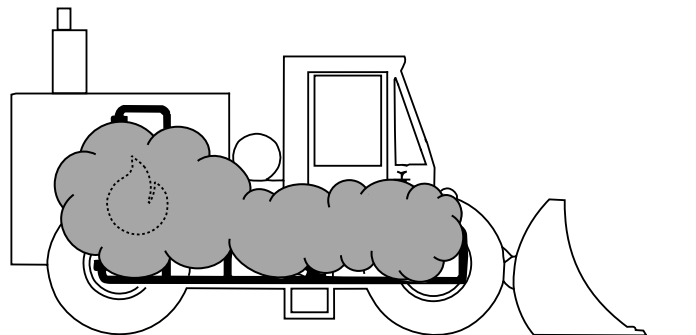

002780

And you can have automatic 24 hour protection with ANSUL CHECKFIRE Detection and Actuation Systems . . .

How the system works with optional CHECKFIRE Electric Detection and Actuation

1. A fire starts in the protected area.

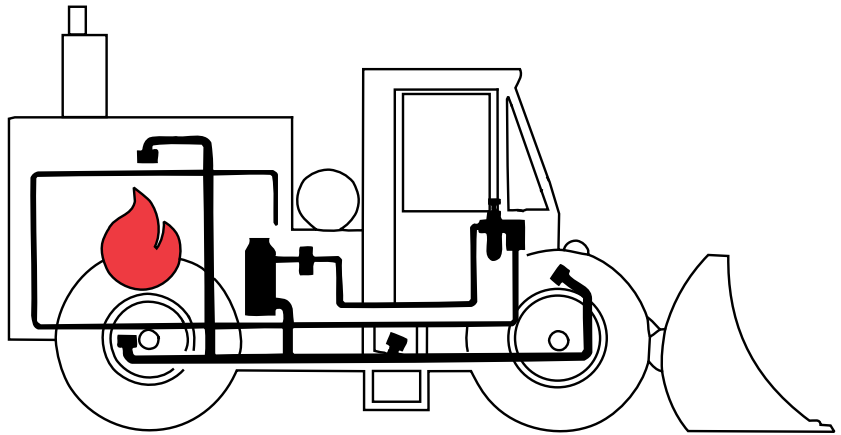

002781

2. Linear, spot detectors, or Triple IR flame detectors signal the system control module indicating that a fire has started in the protected area.

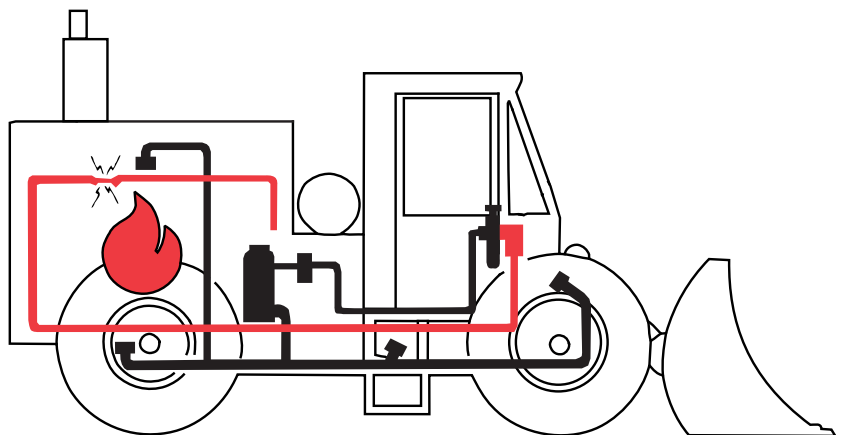

002782

3. The Control Module actuates the fire suppression system. The module will also provide time delay, shut down functions and activation of auxiliary vehicle components in accordance with your installation.

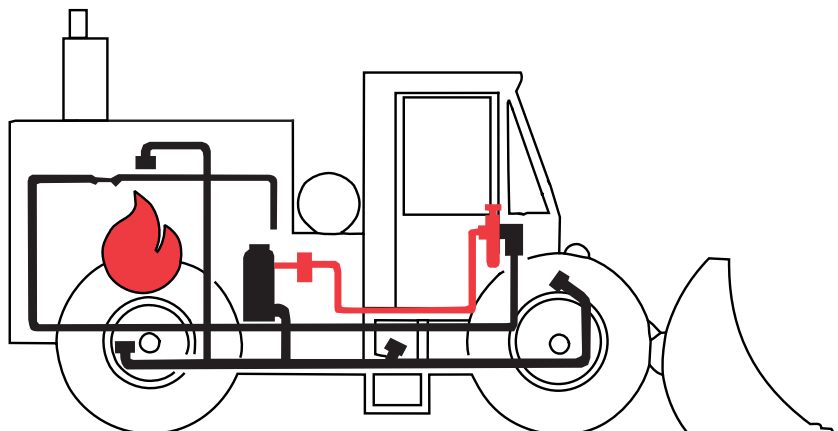

002783

-
4. Expellant gas pressure “fluidizes” the dry chemical extinguishing agent and propels it through the distribution hose.

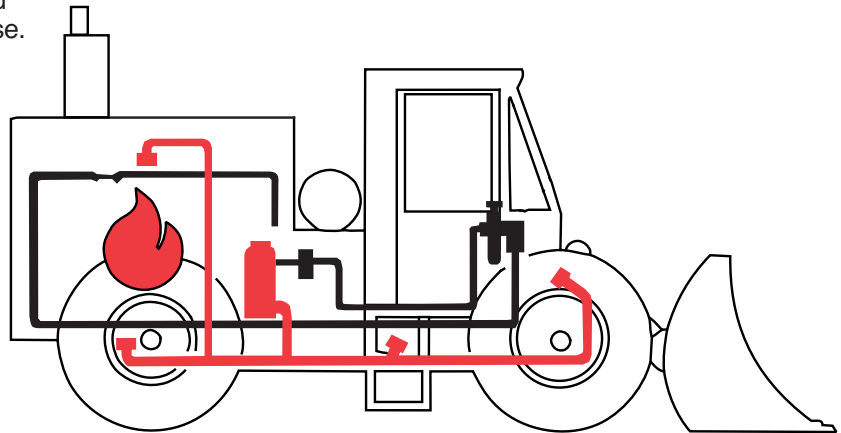

002784

-
5. Dry chemical extinguishing agent is discharged through fixed nozzles into protected areas, to suppress the fire.

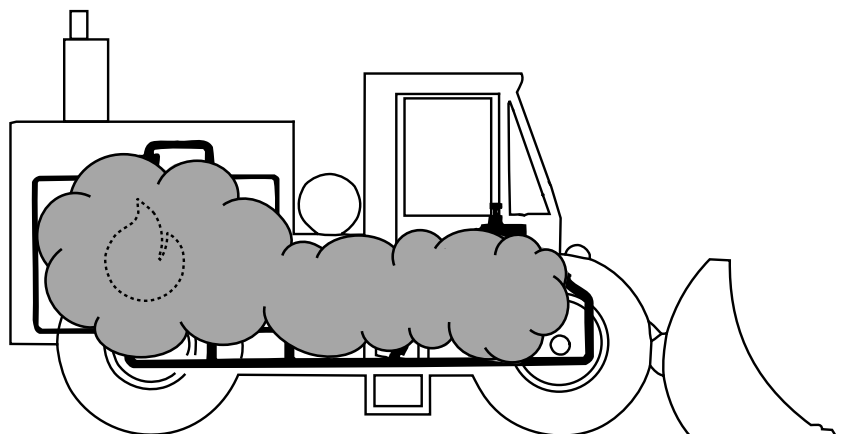

002785

Optional LVS (Twin Agent) Fire Suppression System

Along with dry chemical fire suppression system protection, some vehicles, because of their size, require an additional type of system. This type of system is called a twin agent system. An ANSUL LVS, Liquid Agent System, is designed to discharge wet chemical into the protected hazard areas simultaneously with the dry chemical discharge. The addition of the wet chemical produces a cooling effect onto the flammable fuel and the surrounding surface areas. The wet chemical can flow into hard to reach areas where fuels may have flowed into.

Make sure your ANSUL Fire Suppression System is

The ANSUL Fire Suppression System is your second line of fire defense in case your fire prevention efforts are not enough. However, in order to perform properly, your ANSUL System requires periodic inspection and maintenance.

Nozzles

BLOW-OFF CAPS IN PLACE

NOZZLES NOT CLOGGED OR COVERED WITH DEBRIS

NOZZLES TIGHT IN BRACKETS

002797 002798 002799

System Hydraulic Hose

NO CUTS

ALL FITTINGS TIGHT

NO ABRASIONS

ALL HOSE MOUNTS SECURELY WELDED OR BOLTED

NO KINKS IN HOSE

002786

Agent Tank A-101

AUTHORIZED ANSUL DISTRIBUTOR CERTIFICATION TAG ATTACHED

NO EXCESSIVE WEAR

NO CORROSION

FIRMLY MOUNTED

002794

Agent Tank LVS or LT-A-101-125/250

FIRMLY MOUNTED

NO EXCESSIVE WEAR

NO CORROSION

NO ABRASIONS

NO CORROSION

FIRMLY MOUNTED

004320

Hand Portable Fire Extinguisher

VISUAL SEAL IN PLACE

DISTRIBUTOR CERTIFICATION

NO EXCESSIVE WEAR

NO CORROSION

FIRMLY MOUNTED

002788

kept in good working order.

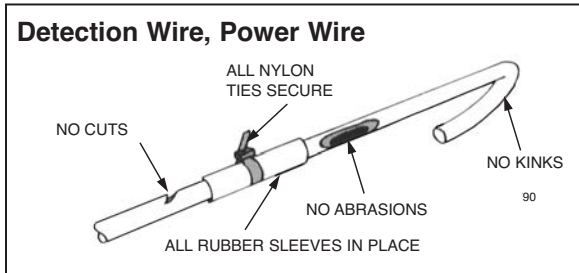
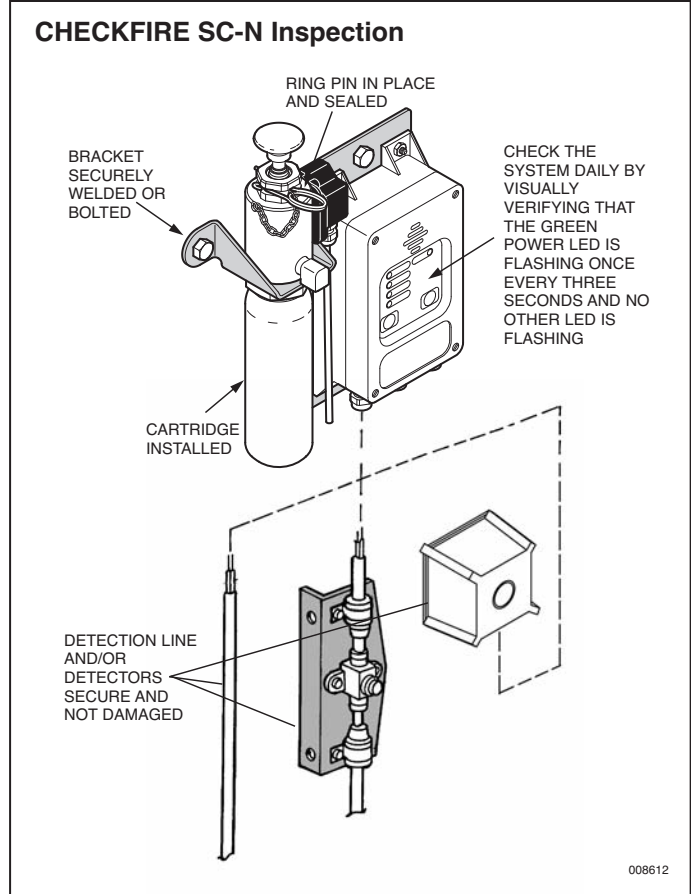
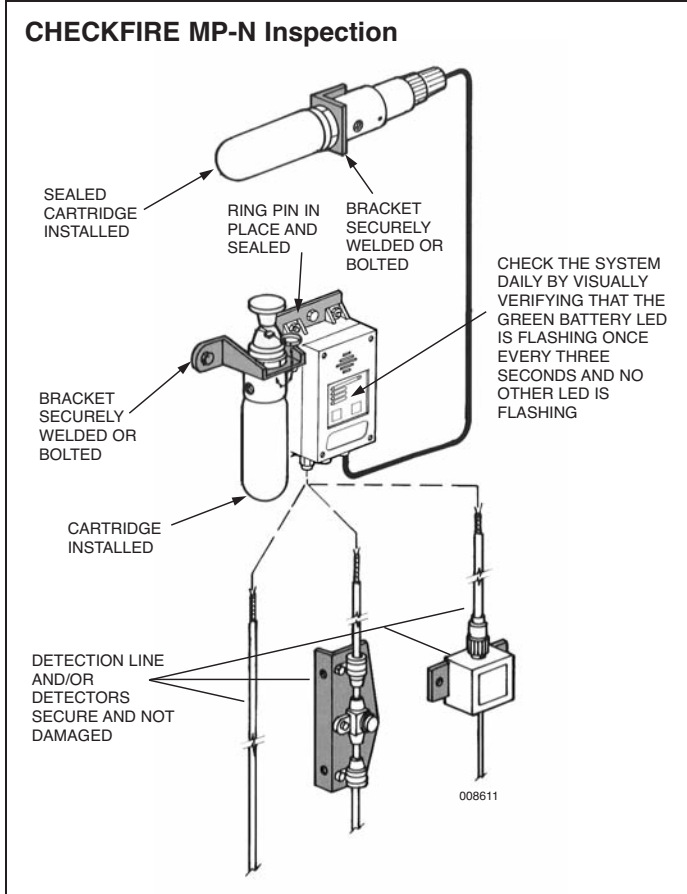

Provide for vehicle modification

Your ANSUL Fire Suppression System was custom designed and installed on your vehicle to protect specific hazard areas from fire. Should you add accessory equipment to your vehicle at a later date, or make major mechanical modifications, you may be reducing the capabilities of the ANSUL Fire

Suppression System. When such modifications are made, contact your ANSUL distributor. He can reevaluate your ANSUL System to ensure it protects all hazard areas from fire.

Provide for periodic maintenance

Periodic maintenance is essential to ensure that your ANSUL Fire Suppression System is operational. Contact your ANSUL distributor for periodic follow-up, in-depth inspection and maintenance.

Protect against fires outside of the hazard area

Hand portable fire extinguishers are an effective way to suppress fires which may occur away from the vehicle, or in areas not protected by the ANSUL Fire Suppression System. Your ANSUL distributor can recommend the proper size, type and placement of hand portable extinguishers and train your personnel in their operation, inspection and maintenance.

Should fire occur in an area not protected by the ANSUL Fire Suppression System, a hand portable fire extinguisher should be employed as follows:

- 1.** Shut off the vehicle's engine and set brakes.
- 2.** Evacuate the vehicle and secure a hand portable fire extinguisher.
- 3.** Approach the fire from the upwind side.
- 4.** Actuate the hand portable fire extinguisher per instructions printed on the extinguisher's nameplate.
- 5.** Once the fire is extinguished, stand by in case the fire reflash.

In the event of a fire on your vehicle

To manually operate system:

1. Shut off the vehicle

2. Set the brakes

3. Pull the ring pin on manual actuator and strike the red button

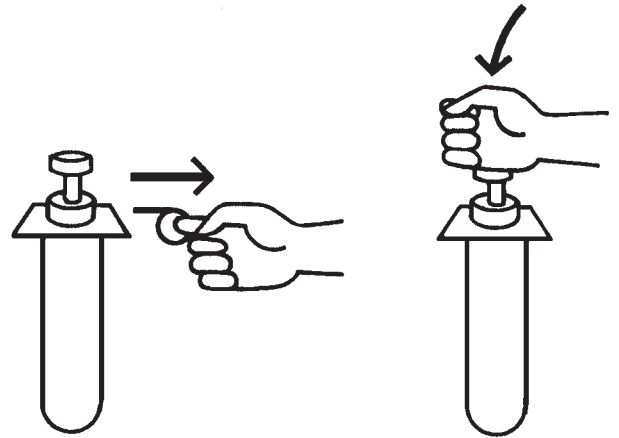

000627

4. Evacuate the vehicle

5. Stand by with a fire extinguisher

Inspection and Maintenance Record

Date	Authorized ANSUL Distributor	Recharge	Inspection	Action Taken

Your Authorized ANSUL Distributor